

Acoustic Emission Detection Using Fiber Bragg Gratings

Ignacio Perez^a, Hong-Liang Cui^b, and Eric Udd^c

^aNaval Air Warfare Center, Patuxent River, MD 20670

^bStevens Institute of Technology, Hoboken, NJ 07030

^cBlue Road Research, Fairview, OR 97024

ABSTRACT

A systematic study of acoustic emission detection using fiber Bragg grating sensors is presented. In this, we attempt to use the fiber Bragg grating to sense the dynamic strain created by a passing ultrasonic wave signal. Our goal is to see if such a sensor is possible, and if so, what the detection sensitivity and limitations will be. To answer these questions, we carried out several experiments involving the detection of simulated acoustic emission events. In the first experiment, we attach a fiber Bragg grating to the surface of a piezoceramic resonator, which is driven by a signal generator. We were able to detect the resulting surface vibration of the resonator up to 2.1 MHz. In the second experiment, we attach a fiber Bragg grating to the surface of an aluminum plate. We excite an acoustic wave using an ultrasonic transducer located at various positions of the aluminum plate. In this way, we demonstrated that the fiber Bragg Grating sensor is capable of picking up the signal coming from a distance (up to 30 cm) for up to 2.5 MHz. In a third experiment, we use the same fiber Bragg grating on aluminum plate set up, but set up an acoustic signal by either a gentle knock on the plate by a pin, or by breaking a pencil lead on the plate. We were able to detect acoustic emission set up by pencil lead breaking up to a frequency of 30 kHz. Higher frequency components were not detected mainly due to the limitation of available electronic equipment at this time (higher frequency band-pass filters and amplifiers). In all the above-mentioned experiments we use a match Bragg grating to demodulate the detected optical signal and use a dual channel scheme for electronic data acquisition and processing (a signal channel and a reference channel).

Keywords: Acoustic emission detection, Fiber Bragg gratings sensors.

1. INTRODUCTION

We describe results from an experimental program of using optical fiber Bragg gratings to detect acoustic emission (AE) signals. As is well-known, when cracks initiate and develop in a structure due to fatigue and loading [1], there are always associated bursts of acoustic energy in the form of ultrasonic waves emanating from the cracks and propagating through the structure. Thus, detection of AE signals can give early indication and warning of structural failure. To date, most AE detection apparatus are based on application of ultrasonic transducers, which is not easily integrated into the structure itself for *in situ* detection and monitoring. On the other hand, fiber Bragg gratings [2-4] are easily embedded in the structure without affecting the structural integrity of the structure itself, or surface-mounted non-intrusively. Furthermore, fiber gratings are ideal for multiple sensor applications as many of these gratings can be employed either in series or in parallel. In this respect, many of the multiplexing technologies developed in the telecommunication industry can be directly applied. These include time division multiplexing and wavelength division multiplexing. Thus, it is reasonable to envision in the near future of embedding hundreds of fiber Bragg gratings on an airplane wing to continuously monitor the structural integrity of the wing in flight. To be sure, there is a multitude of technical challenges that must be overcome to make this a reality. First, the detection sensitivity must be very high. This is especially important since AE events are usually buried in a noisy environment. Secondly, detection speed must be high enough to capture instantaneously most of the frequency contents of an AE signal. Thirdly, one must develop a sophisticated computer-based real-time data acquisition, processing, and analysis system in order for the AE sensors to be truly effective. These challenges must be overcome through systematic experimentation in conjunction with simulation and modeling. Here, we report our recent work in characterizing the fiber Bragg grating as an AE sensor [5].

2. EXPERIMENTS WITH PIEZOCERAMIC RESONATORS

To establish the detection sensitivity and speed of the fiber Bragg grating sensors, we first performed a series of experiments with the sensors using controlled generation of ultrasonic signal. The latter was accomplished employing PZT acoustic resonators driven by a pulse generator (Ritec RAM-10000). The fiber gratings are glued to the side surface of the acoustic resonator, so that when the resonator is set into vibration in its thickness-extension mode, the fiber grating is stretched and shortened periodically at the frequency of the acoustic resonator. A super-radiant luminescent light source was employed to

send light (centered at 1300 nm, with a spectral width of 30 nm, and a peak power of 1.3 mW) down the fiber. A high-speed photodetector converts the light signal back to electrical signal, which is displayed on a digital oscilloscope. (See Figure 1 for a block diagram of the experimental setup.)

As the PZT resonators have resonant frequencies ranging from 200 kHz to 2 MHz, we were able to investigate the response of our fiber Bragg grating sensors to AE signals over the entire frequency domain mentioned above. However, the frequency response is not uniform across the frequency domain, as different resonators have quite different resonant frequency and displacement characteristics. Most of our data were taken near resonance, for the response falls sharply away from resonance. For demodulating the optical response signal, we used a tunable matching fiber Bragg grating. We found that this demodulator is very sensitive to small optical intensity change at extremely high speed.

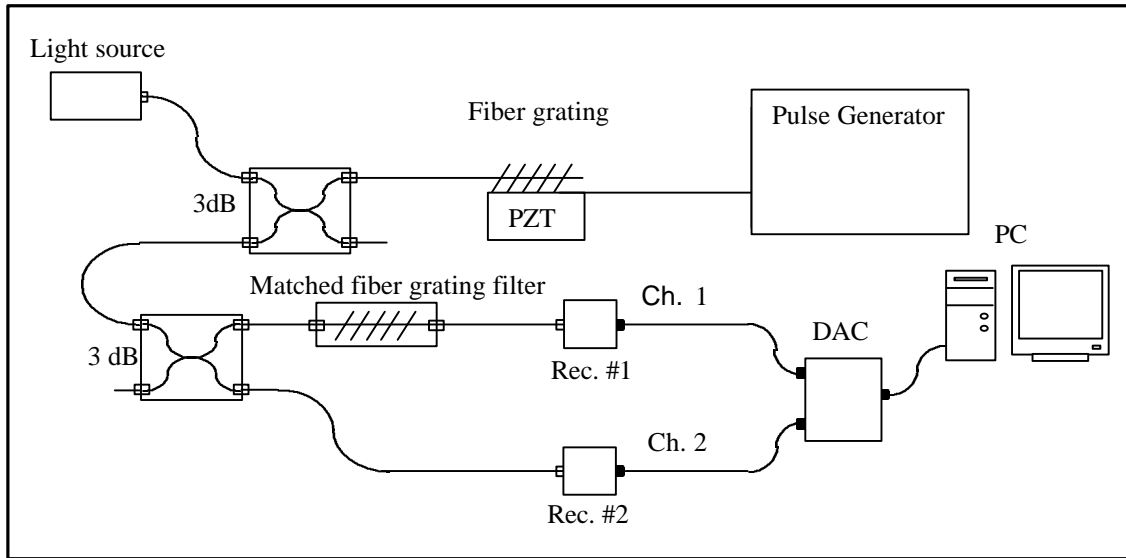

Figure 1. Block Diagram of the experimental setup.

Data were taken in the form of photoreceiver voltage response to the light signal. In this, only the AC component is recorded (the DC voltage, of the order of several volts, carries no direct information on the AE signal.) The data taking commences when a trigger signal is received from the pulse generator, which is clocked to coincide with the onset of the sinusoidal wave train. Typically, about 10 cycles of sinusoidal voltage wave is applied, with amplitude of a few hundred volts. Figure 2 shows a typical waveform of the signal, the trigger, and the response, at a frequency of 355 kHz. Table 1 summarizes the response of several fiber Bragg grating detectors at various frequencies. The data were taken using several PZT resonators as indicated.

Table 1. Detector response with a tunable 6 mm FBG as demodulator

Frequency	1 mm detector	2 mm detector	4 mm detector	6 mm detector
235 kHz a				17.19 mV
330 kHz a				9.06 mV
332 kHz b	16.25 mV	19.38 mV	18.75 mV	
525 kHz b	15.00 mV	21.56 mV	17.81 mV	
1.10 MHz c				5.94 mV
2.15 MHz d				12.50 mV

a: 0.25" resonator; b: 0.16" resonator; c: 0.08" resonator; d: 0.04" resonator

From our experimental investigation a lower detection limit has been established for AE detection using fiber Bragg gratings. The lowest driving voltage employed when a signal is still clearly registered is about 10 volts. This gives a net displacement of the resonator surfaces (relative to each other) of about 2×10^{-11} m. At 2 MHz, the resonator thickness is 0.04", which gives a

minimum detectable strain of about 0.02 μ strains. This kind of detection sensitivity is approaching the currently available methods of acoustic emission detection.

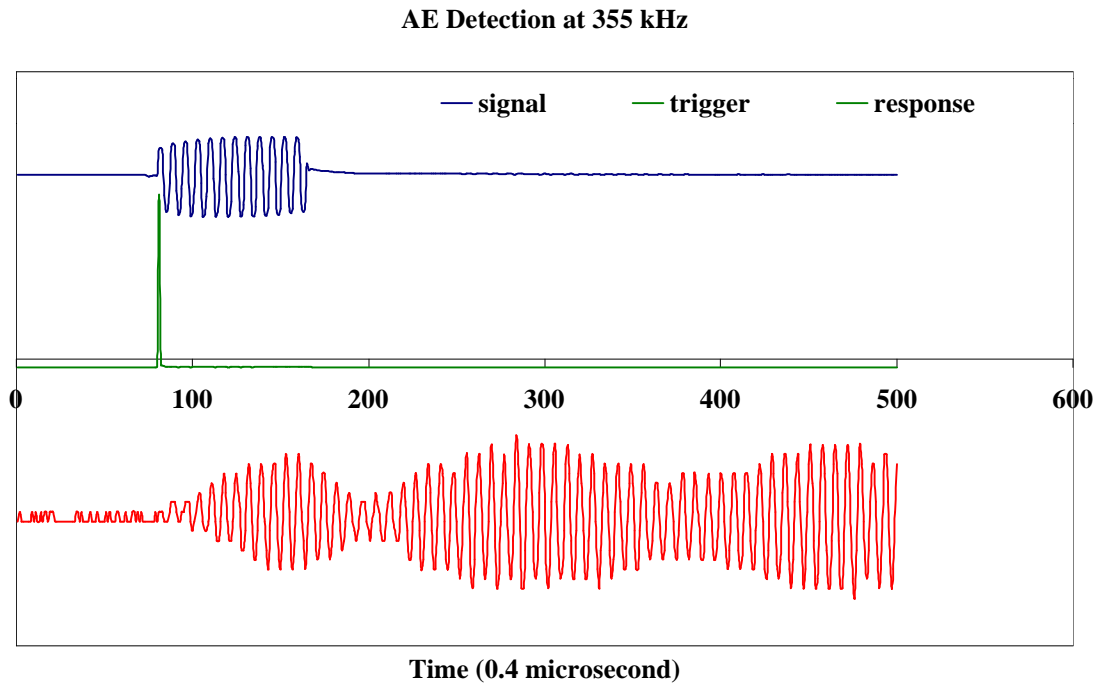

Figure 2. Pulse signal, trigger, and response at 355 kHz.

3. EXPERIMENTS WITH ULTRASONIC TRANSDUCERS AND ALUMINUM PLATES

In a second experiment we replaced the PZT resonators with an aluminum plate of dimension 24" x 12" x 1/4". We bonded a fiber Bragg grating sensor on the top surface of the aluminum plate. A sound wave is launched into the plate by an ultrasonic transducer in contact with the top surface of the plate. The rest of the experimental setup is the same as described earlier in conjunction with the PZT resonator experiments. The ultrasonic transducer is driven by the Ritec RAM10000 pulser. In order to determine the sensitivity of the fiber Bragg grating sensor we varied the distance between the fiber Bragg grating sensor and the ultrasonic transducer. Furthermore, in order to assess the directional dependency of the detection sensitivity we also varied the direction of propagation of the sound wave relative to the direction of the fiber Bragg grating. Specifically, measurements were made along three straight lines connecting the fiber Bragg grating and the ultrasonic transducer. Line a is perpendicular to the direction of the fiber Bragg grating; line b is at 45-degree angle with respect to the direction of the grating; line c is parallel to the direction of the grating.

The output signal from the photodetector is amplified by a preamplifier (40 dB gain) followed by an amplifier (20 dB gain). Clear signals can be detected at the maximum separation allowed by the aluminum plate dimension (~ 30 cm). We used transducers of various center frequencies but most concentrated in the spectral region from 300 kHz to 1 MHz. Figure 3 shows the response of the detector relative to the noise level (at 310 mV) for various distances along the three directions mentioned before.

Data in Figure 3 show strong dependence on both the direction of propagation of the sound wave relative to the fiber grating orientation and the separation between the grating and the transducer. Both are to be expected based on our understanding and simulation of the coupling of sound wave with optical wave through a fiber Bragg grating [5]. The distance dependence stems from the attenuation of sound energy away from its source and the directional dependence has to do with the fact the fiber grating response most effectively to longitudinal waves that stretch/compress it. Further refinement of the technique seems to hinge on the improvement of signal to noise ratio, which in turn, calls for better amplifiers with higher gain and

better noise filtering features. Such problems notwithstanding, our preliminary results have been very encouraging. Figure 5 and Figure 6 show typical detected waveforms at 500 kHz, at a distance of 5 cm and 15 cm, respectively.

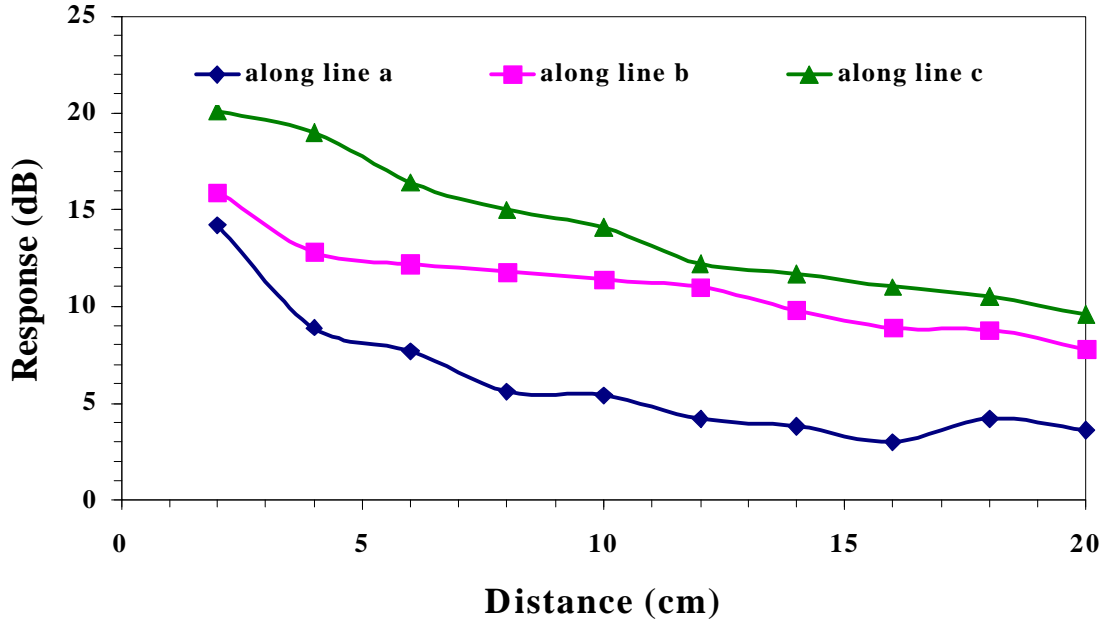

Figure 3. Response of the detector versus the distance between the detector FBG and the ultrasonic transducer at 1 MHz. The noise floor at 310 mV is taken as the reference. Measurements were taken along three straight lines: line a – perpendicular to the grating direction; line b – 45 degrees from line a; line c – parallel to the grating direction.

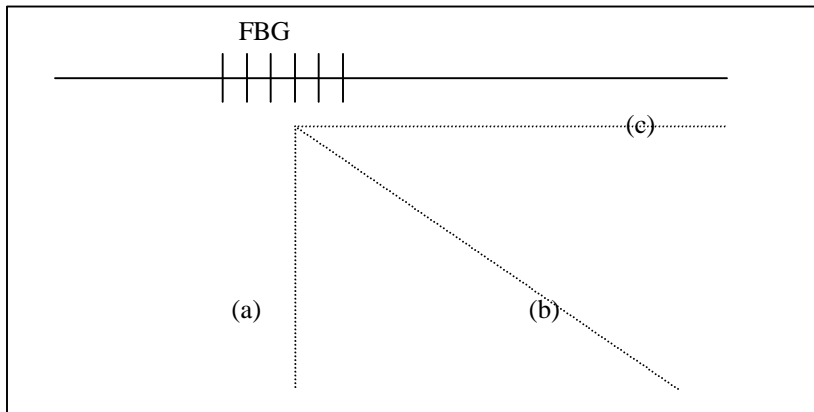

Figure 4 Schematics of the measurement setup. See caption of Figure 3 for details.

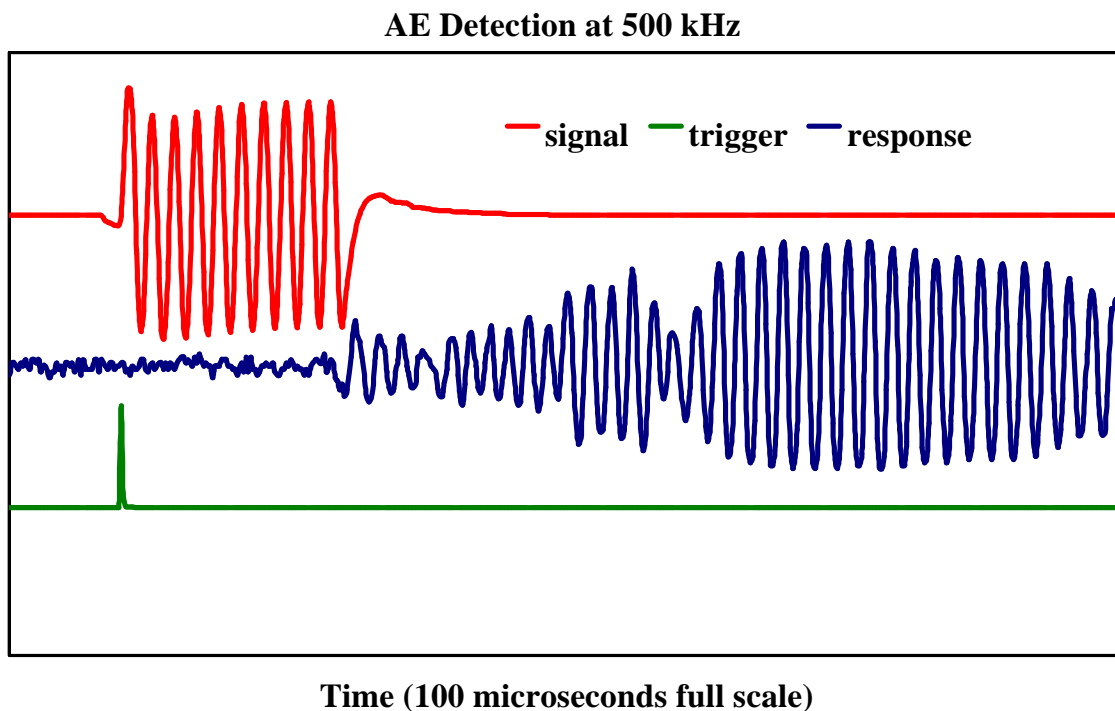

Figure 5 Detection of acoustic emission signal at 500 kHz. The fiber Bragg grating detection is at a distance of 5 cm from the ultrasonic transducer.

4. EXPERIMENTS WITH PENCIL LEAD BREAKING AND ALUMINUM PLATE

In a last set of experiments we attempted to detect acoustic emission signal generated by breaking a pencil lead on the aluminum plate described in Section 3. We were able to detect the AE signal's frequency components up to 30 kHz, mainly limited by available electronic filters and amplifiers beyond that.

The experimental setup is essentially the same as in the experiments described in Section 3. Two major changes were: 1. a 3-port optical circulator replaced the first 2x2 3dB coupler, and 2. the acoustic emission signal is now generated by pencil lead breaking. The detection fiber Bragg grating is again bonded to an aluminum plate.

We were able to detect AE signal generated by pencil lead breaking on the aluminum plate on which the fiber Bragg grating detector was bonded. A typical photodetector response is shown in Figure 7. In obtaining this result, the electronic bandpass filter's center frequency was set at 30 kHz, and the total electronic gain was 80 dB.

AE Detection at 500 kHz

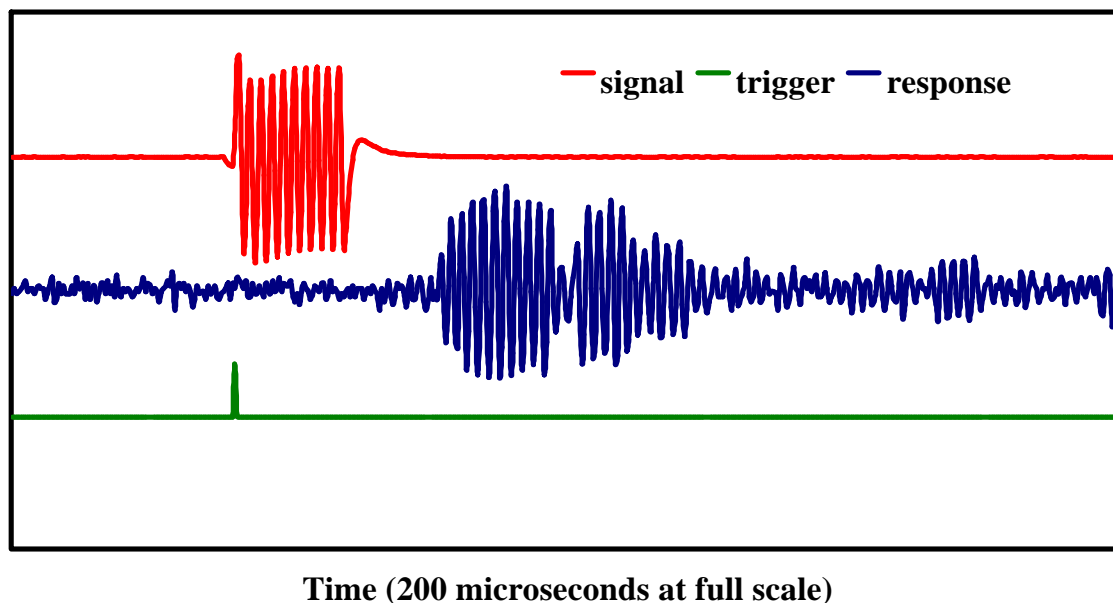

Figure 6 Detection of acoustic emission signal at 500 kHz. The fiber Bragg grating detector is at a distance of 15 cm from the ultrasonic transducer.

5. DISCUSSION AND CONCLUSIONS

We have performed a series of experiments to test the feasibility and limitation of using optical fiber Bragg gratings to detect acoustic emissions. These experiments differ mainly from one another in the way the acoustic emission signal was generated. In the first experiment, it was generated by piezoceramic resonators; in the second experiment, it was generated by ultrasonic transducers; and in the third experiment, it was generated by pencil lead breaking. Our experiments show that dynamical strain of the order of 10^{-2} μ strain and smaller and frequency of the order of 1 MHz is detectable with our fiber optic Bragg grating sensors.

In conclusion, we have obtained very promising experimental evidence that fiber Bragg gratings may be used to detect acoustic emission events. This detection method is very sensitive, highly reliable, and can be easily adapted to structural monitoring. As this study is still preliminary, we hope to report more in-depth investigation of AE detection using fiber Bragg gratings in the near future.

Response to AE from Pencil Lead Breaking

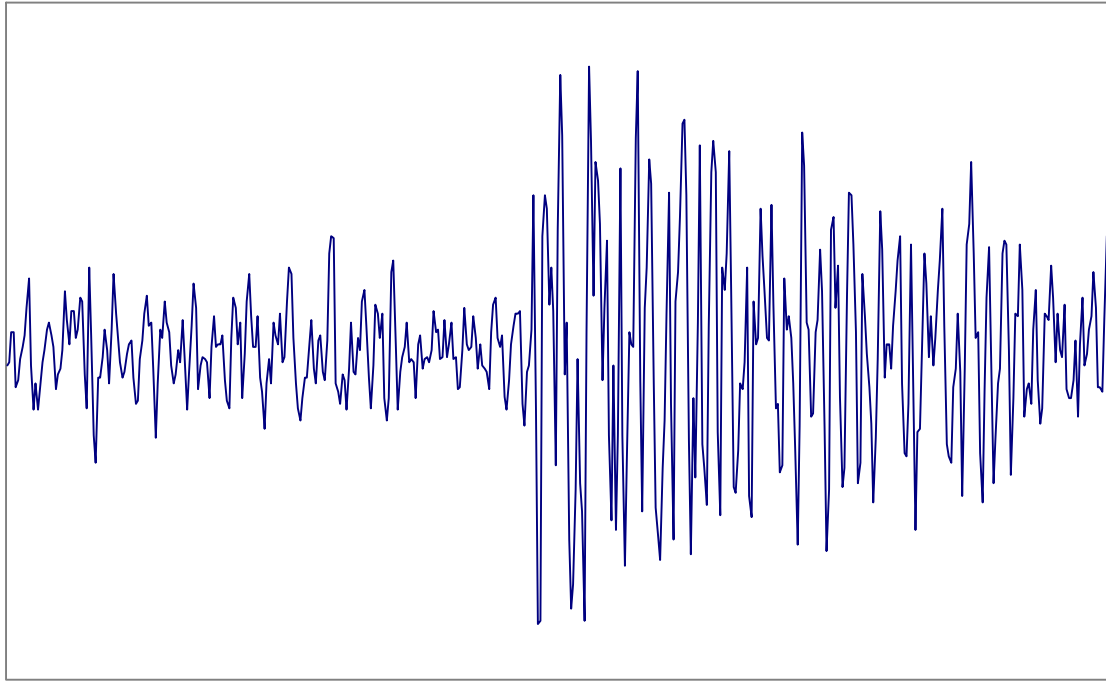

Figure 7. Fiber Bragg grating detector response to a pencil lead breaking event. The bandpass filter is set at 30 kHz.

6. ACKNOWLEDGMENTS

This work was supported by the Office of Naval Research.

7. REFERENCES

1. R.K. Miller and P. McIntire, "Nondestructive Testing Handbook", vol. 5, Acoustic Emission Testing, American Society for Nondestructive Testing, Columbus, OH, 1992.
2. K.O. Hill, Y. Fujii, D.C. Johnson, and B.S. Kawasaki, *App. Phys. Lett.*, **32**, 647 (1978).
3. G. Meltz, W.W. Morey, and W.H. Glenn, *Opt. Lett.* **14**, 823 (1989).
4. G. Meltz, W.W. Morey, and J.R. Dumphy, *SPIE* **1587**, 350 (1991).
5. I.M. Perez, H.L. Cui and E. Udd, 7th Int. Symp. On Smart Structures and Materials, Newport Beach, CA, March, 2000.